



POWER AMPLIFIER

H7000

H5000

H3000

OWNER'S MANUAL
MANUEL D'UTILISATION
BEDIENUNGSANLEITUNG

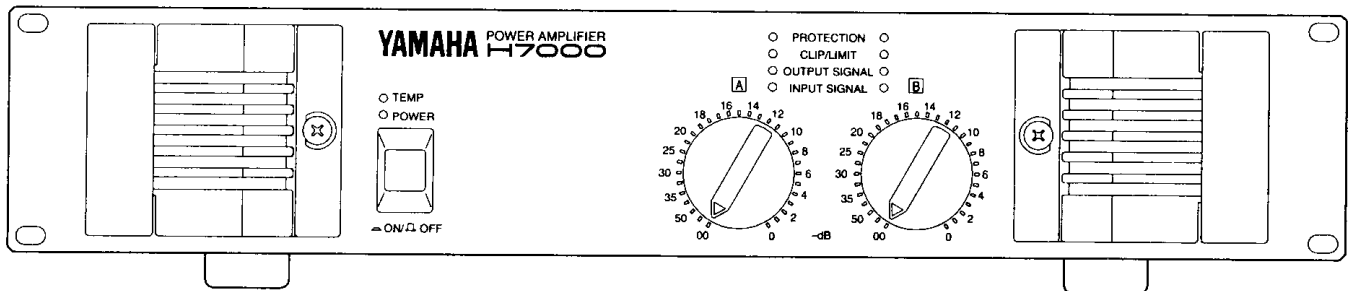

Thank you for purchasing a Yamaha H7000/5000/3000 Series Power Amplifier. The Yamaha 'H' Series offer high power, performance, and reliability in a compact chassis. Audio integrity is maintained through Yamaha's renown attention to circuitry detail. Amplifiers can be used in one of three modes: Stereo, Bridge, or Parallel. In Stereo mode, channels A and B operate independently, just like a typical stereo amplifier. In Bridge mode, channels A and B are bridged together and work as one mono amplifier, providing high-power capabilities. In Parallel mode, channel A input signal is fed to both channel A and channel B power amps.

Protection systems include: soft-start power on/off, heat sink overheat, and power limit for abnormally low impedances. Protection status is shown by front panel LED indicators, along with power, clip, output signal, and input signal indicators. Input connectors include XLR type and phone jacks. Input signals can be linked through to other power amplifiers using XLR type cables. Output connections feature heavy-duty binding posts. A ground-lift switch can be used to eliminate hum loops.

Please read through this manual in order to take full advantage of the H7000/5000/3000 power amplifiers.

Note: This manual covers the Yamaha H7000, H5000, and H3000 power amplifiers. These amplifiers differ only in output power, the feature set is the same for each.

Contents

Introduction	1
Precautions	2
Operation	3
Installation Details	5
Caution for Speaker Connection	7
Specifications	8
MONITOR/REMOTE Connection Pin Outs	10
Troubleshooting	10
Cleaning the Filter Elements	11
Dimensions	Add-1
Performance Graphs	Add-2
Block Diagram	Add-6

Precautions

- 1. Avoid Excessive Heat, Humidity, Dust and Vibration**
Keep the unit away from locations where it is likely to be exposed to high temperatures or humidity — such as near radiators, stoves, etc. Also avoid locations which are subject to excessive dust accumulation or vibration which could cause mechanical damage.
- 2. Avoid Physical Shocks**
Strong physical shocks to the unit can cause damage. Handle it with care.
- 3. Do Not Open The Case Or Attempt Repairs Or Modifications Yourself**
This product contains no user-serviceable parts. Refer all maintenance to qualified Yamaha service personnel. Opening the case and/or tampering with the internal circuitry will void the warranty.
- 4. Make Sure Power Is Off Before Making Or Removing Connections**
Always turn the power OFF prior to connecting or disconnecting cables. This is important to prevent damage to the unit itself as well as other connected equipment.
- 5. Handle Cables Carefully**
Always plug and unplug cables — including the AC cord — by gripping the connector, not the cord.
- 6. Clean With a Soft Dry Cloth**
Never use solvents such as benzine or thinner to clean the unit. Wipe clean with a soft, dry cloth.
- 7. Always Use the Correct Power Supply**
Make sure that the power supply voltage specified on the rear panel matches your local AC mains supply. Also make sure that the AC mains supply can deliver more than enough current to handle all equipment used in your system.

IMPORTANT NOTICE FOR THE UNITED KINGDOM

Connecting the Plug and Cord

WARNING: THIS APPARATUS MUST BE EARTHED

IMPORTANT: The wires in this mains lead are coloured in accordance with the following code:

GREEN-AND-YELLOW	: EARTH
BLUE	: NEUTRAL
BROWN	: LIVE

As the colours of the wires in the mains lead of this apparatus may not correspond with the coloured markings identifying the terminals in your plug, proceed as follows:

The wire which is coloured GREEN and YELLOW must be connected to the terminal in the plug which is marked by the letter E or by the safety earth symbol or coloured GREEN and YELLOW.

The wire which is coloured BLUE must be connected to the terminal which is marked with the letter N or coloured BLACK.

The wire which is coloured BROWN must be connected to the terminal which is marked with the letter L or coloured RED.

* This applies only to products distributed by YAMAHA KEMBLE MUSIC (U.K.)

Operation

■ Front Panel

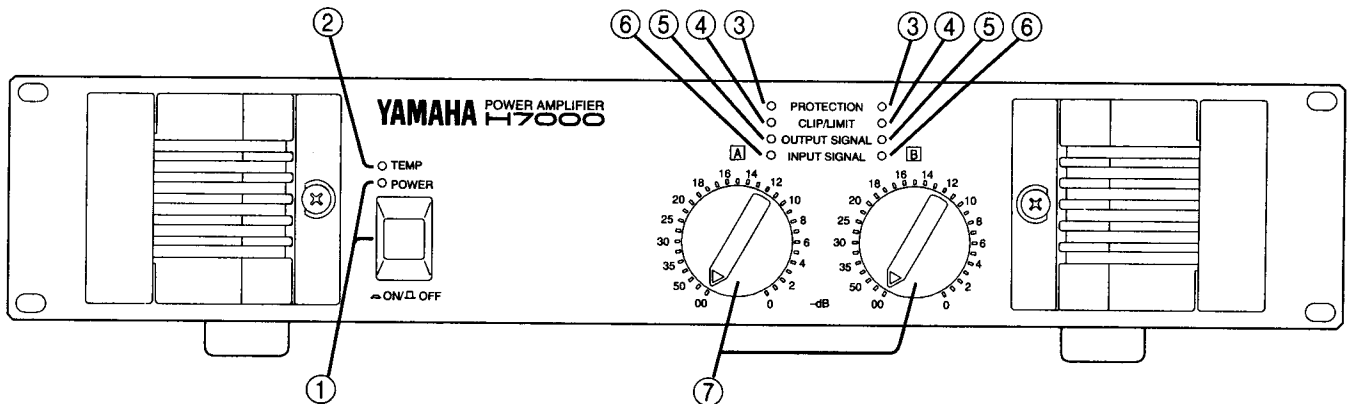

① POWER switch & indicator

Pressing this switch turns the power ON, and pressing again turns the power OFF. The indicator lights when the power is ON.

② TEMP indicator

This indicator flashes when the heat sink temperature exceeds 85°C (185°F).

③ PROTECTION indicators

The PROTECTION indicator lights for approximately 6 seconds after the POWER switch is pressed to indicate that the protection circuitry is operating. No sound is output from the speakers while this indicator is lit. This indicator will also light and sound will be cut off to the speakers if the protection circuitry is activated at any other time during amplifier operation due to factors such as overheating or the detection of excessive DC voltage at the outputs. When the problem is corrected, the protection circuitry is automatically deactivated, the indicator goes out, and the amplifier resumes normal operation.

④ CLIP/LIMIT indicators

The CLIP/LIMIT indicators light if the output distortion exceeds approximately 0.5%. These indicators, which are independently provided for each channel, indicate that an excessively large input signal is being applied to the amplifier causing clipping to occur. They also indicate that the limiter is active.

⑤ OUTPUT SIGNAL indicators

The SIGNAL indicators light when the output voltage at the speaker terminals exceeds 2 Vrms. This is equivalent to 1/2 watt with an 8 Ω load or 1 watt with a 4 Ω load.

⑥ INPUT SIGNAL indicators

These indicators light up when the input signal level exceeds -40 dBm.

⑦ Input attenuators

The input attenuators are 31-position click-stop controls used for adjusting input sensitivity. Rotating fully in the clockwise direction sets the attenuator at 0 dB, while rotating fully in the counterclockwise direction provides infinite attenuation.

⑧ Knob Locks

Push these locks over the attenuation controls to prevent accidental resetting of the levels. Pull them off again if you need to reset the levels.

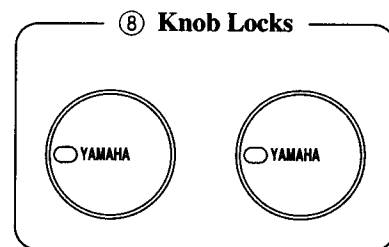

■ Rear Panel

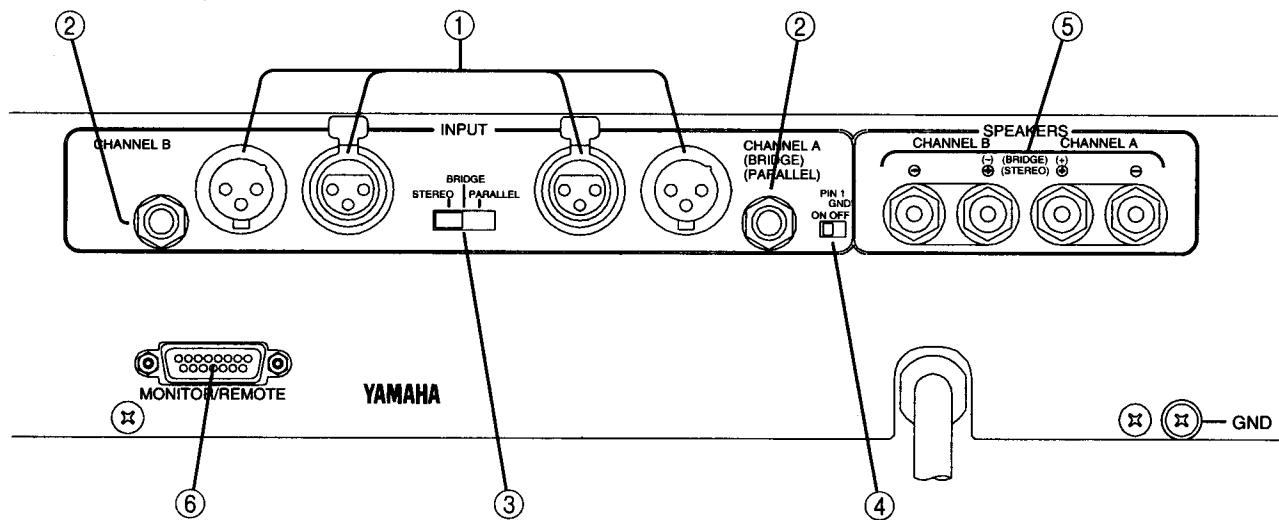

① XLR type INPUT connectors

The INPUT connectors are balanced, XLR-3-31 type input connectors. They are wired with Pin 1 as ground, Pin 2 as signal hot, and Pin 3 as signal cold. As connectors, they conform to Cannon XLR-3-12C Switchcraft 5C-1055A standards. The XLR-3-32 type connectors can be used to link the input signal through to other amplifiers.

② Phone jack INPUT connectors

These 1/4-inch balanced TRS connectors accept balanced and unbalanced input signals.
Tip=hot, Ring=cold, Sleeve=ground.

③ STEREO/BRIDGE/PARALLEL MODE switch

This switch sets the amplifier for Stereo, Bridge, or Parallel operation. Make sure that the amplifier is powered off before setting this switch.

— STEREO —

In this mode, channels A and B operate independently (typical stereo amplifier). Channel A input signal feeds channel A power amp, and channel B input signal feeds channel B power amp.

— BRIDGE —

In this mode, channels A and B are bridged together and work as one mono amplifier.

Operation:

- 1) Turn the POWER switch OFF.
- 2) Set the rear panel MODE switch to BRIDGE.
- 3) Connect the channel A input connector to the signal input source. (The channel B input connector cannot be used.)
- 4) Adjust the input level with the channel A input attenuator.
- 5) Connect the "+" speaker lead to the "+" speaker terminal of channel A, and connect the "-" speaker lead to the "-" speaker terminal of channel B. The "-" speaker terminals on the amplifier are not used.

— PARALLEL —

In this mode, channel A input signal feeds channel A power amp and channel B power amp. Channel B input connections are not used. Channel A and B input attenuators can be set independently.

④ PIN 1 GND switch

This is a ground-lift switch that separates the input connector's pin 1 ground from the chassis ground. This can be used to eliminate hum loops in multi-device systems.

⑤ SPEAKER terminals

These are used for connecting the speakers. The red terminal is connected to the speaker's "+" connector and the black terminal is connected to the "-" connector.

Refer to page 7 for details on speaker connection.

⑥ MONITOR/REMOTE connector

For remote control and monitoring, a custom built remote/monitor unit can be connected here. This is provided for installers and engineers who require such a facility. Note that Yamaha do not make a remote/monitor unit. Through this connection, channels can be muted, the amp powered on and off, various front panel status indicators can be checked, and output signals (pre output relay) can be monitored. For full details, see the pin out table at the rear of this manual.

Installation Details

Make sure that the amplifier has adequate ventilation. The unit is equipped with a twin fan cooling system. For this reason the airflow to the front and rear panels should not be blocked.

■ Permanent Rack Mounting

When high-powered amplifiers are rack mounted, the heat generated from each amplifier can build up inside the rack causing excessive temperatures. This is especially true if there is no rear opening in the rack mount enclosure. To lower the interior temperature, it is necessary to improve the ventilation of the rack mount. Since warm air rises to the top of the rack mount, cooling will be most effective if air can be expelled from the top directly.

1. When the amplifier is rack mounted, sufficient ventilation to the inside of the rack must be provided. For best ventilation results, the rear of the rack should be kept fully open. If a rear panel must be installed, it will be necessary to provide one 1U-size blank panel with ventilation slots for every four amplifiers at the uppermost installation space in the front or rear panel of the rack. (See Figure 1.)
The optional Yamaha VP1 Ventilation Panel is recommended for use as a blank panel.
2. Make sure that a space of at least 100 mm exists between the power amplifier's rear panel and the rear of the rack.
3. Place the rack in a well-ventilated location.
4. When a power amplifier is mounted in a rack with other types of components, be careful that the heat generated by the power amplifier does not affect the other components.

Ventilated Panel

Yamaha VP1 ventilation panel may be provide as an optional accessory (open area should be at least 35% of total area).

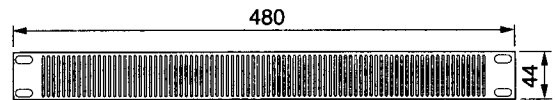
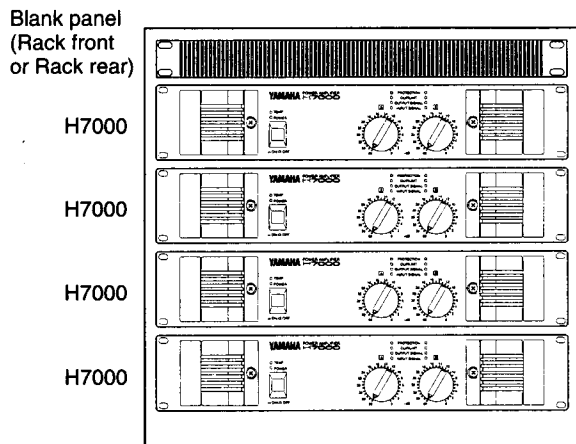

Unit: mm

Fig. 1; Rack mounting with ventilated panels

■ Portable Rack Mounting

The amplifier intakes cool air through the front panel and exhausts warm air out the rear panel. When mounting amplifiers in a portable rack, make sure the rear panel is completely open for ventilation.

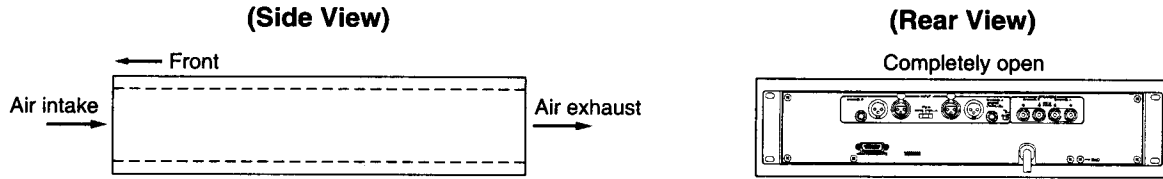

■ Positioning the Housed Amplifier

Place the case so that the ventilation airflow paths are not blocked.

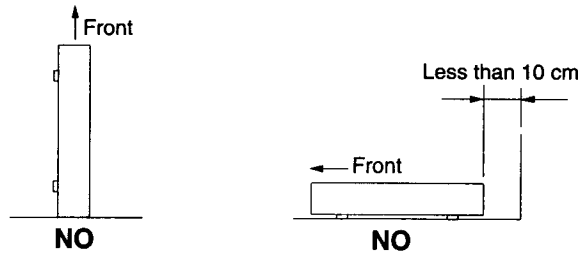

Caution for Speaker Connection

1. Turn off the POWER switch.
2. Remove the cover attachment screws and remove the protective cover from the speaker terminals.
 - * The protective cover is not supplied with the U.S. model.

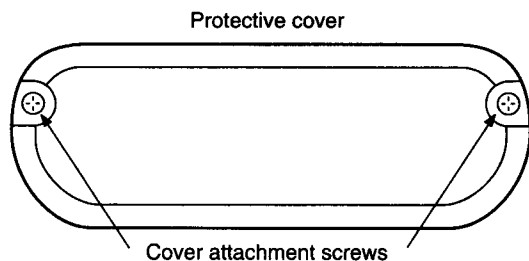

3. After removing approx. 10 mm of insulation from the ends of the speaker cables, pass the bare ends of the speaker wires through the holes in the corresponding speaker terminals and tighten the terminals to securely clamp the wires.

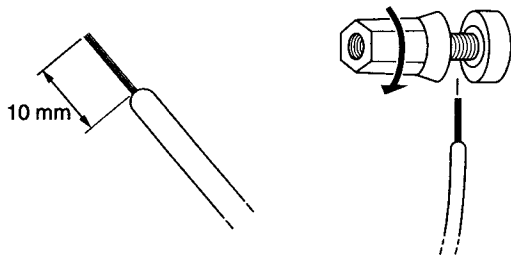

At this time make sure that the bare ends of the speaker cables do not extend from the terminals in such a way that they touch the chassis or protective cover.

Speaker cables fitted with terminal connectors can be inserted from the top. The protective cover has larger apertures at the top for this purpose.

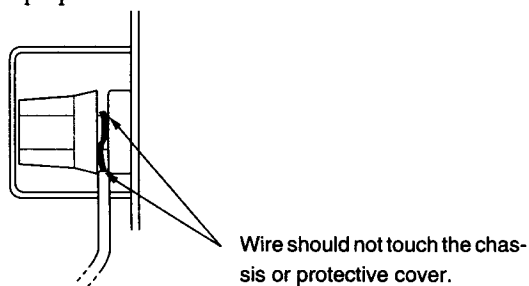

4. Reattach the protective cover over the speaker terminals.

— Speaker output terminals —

Connect the amplifier's A channel and B channel speaker terminals to the corresponding speakers. Make sure that the red terminals on the amplifier are connected to the "+" terminals on the speakers, and that the black terminals are connected to the "-" terminals on the speakers.

Take care that the end of each speaker cable does not short with another end of the speaker cable or with the chassis or protective cover, and secure the wire in place by tightening down the terminal. Also, always make sure that the power is OFF before attaching or removing speaker wires.

- If long speaker cables are required, use cables with as heavy a gauge as possible to protect against degradation caused by the damping factor and to prevent power loss inside the speaker cables.
- Since the 'H' Series of power amplifiers can provide relatively high output powers, it is important that you use a speaker system with sufficient power handling capabilities. If the allowable input power of the speaker system is lower than the rated output power of the amplifier, you can protect the speakers by connecting an in-line fuse between each speaker and the amplifier.

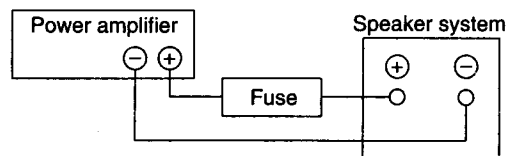

- * You can use the following formula to determine the size of fuse needed for your system.

$$P_o = I^2 R \rightarrow I = \sqrt{\frac{P_o}{R}}$$

- P_o : Continuous allowable input power of speaker (noise or RMS)
 R : Nominal impedance of speaker
 I : Necessary fuse capacity (A)

Example:

Speaker continuous allowable input power; 50 W
Speaker impedance ; 8 Ω
Using these values.

$$I = \sqrt{\frac{50}{8}} = 2.5$$

Necessary fuse capacity = 2.5 (A)

Specifications

■ General Specifications H7000, H5000, H3000

	H7000	H5000	H3000
POWER OUTPUT LEVEL f=20 Hz~20 kHz, THD+N ≤ 0.1%			
STEREO RL=8 Ω	750 W	550 W	350 W
RL=4 Ω	950 W	700 W	450 W
BRIDGE RL=8 Ω	1900 W	1400 W	900 W
FREQUENCY RESPONSE	0 dB+0, -1 dB; f=10 Hz~50 kHz RL=8 Ω, Po=1 W		
POWER BANDWIDTH	10 Hz~50 kHz, Half Power, THD+N=0.1%		
TOTAL HARMONIC DISTORTION (THD+N) f=20 Hz~20 kHz, HALF POWER			
STEREO RL=8 Ω, 4 Ω	≤ 0.05%	≤ 0.05%	≤ 0.07%
BRIDGE RL=8 Ω	≤ 0.05%	≤ 0.05%	≤ 0.07%
INTERMODULATION DISTORTION (IMD) f=60 Hz: 7 kHz, 4:1, HALF POWER			
STEREO RL=8 Ω, 4 Ω	≤ 0.05%	≤ 0.05%	≤ 0.07%
BRIDGE RL=8 Ω	≤ 0.05%	≤ 0.05%	≤ 0.07%
CHANNEL SEPARATION			
HALF POWER, RL=8 Ω	≥ 65 dB, f=20 Hz~20 kHz		
ATT. max. Input 600 Ω shunt	≥ 80 dB, f=1 kHz		
RESIDUAL NOISE			
12.7 kHz LPF	≤ -70 dB; ATT min.		
IHF-A network	≤ -80 dB; ATT min.		
SIGNAL-TO-NOISE RATIO Input 600 Ω shunt			
12.7 kHz LPF	105 dB	103 dB	101 dB
IHF-A network	110 dB	108 dB	106 dB
DAMPING FACTOR	> 200; RL=8 Ω, f=1 kHz		
SLEW RATE 8 Ω FULL SWING			
STEREO	±30V/μs		
BRIDGE	±50V/μs		
SENSITIVITY (ATT max.) Rated Power into 8 Ω	+8 dB	+6 dB	+4 dB
VOLTAGE GAIN (ATT max.)	32 dB		
INPUT IMPEDANCE	30 kΩ (balance), 15 kΩ (unbalance)		
INDICATORS	POWER (STAND-BY) (Red) TEMP; Heatsink Temp ≥ 85°C (185°F) (Red; flashing) PROTECTION (MUTE) (Red) CLIP/LIMIT (Red) OUTPUT SIGNAL × 2 (Yellow) INPUT SIGNAL × 2 (Green)		
PROTECTION	Power SW ON/OFF muting Heatsink temp ≥ 95°C (203°F)		
PC LIMITER	RL ≤ 1 Ω		
LIMITER CIRCUITS	Comp; THD ≥ 0.5% (f=1 kHz)		
FAN CIRCUIT	~ 50°C (122°F) ~ 70°C (158°F) ~ Low-speed - variable - Hi-speed		

CONTROLS	(FRONT) POWER SW; Push on/Push off Attenuator; 31-position dB calibrated (REAR) Mode SW; STEREO/BRIDGE/PARALLEL PIN-1 GND SW; ON/OFF
POWER REQUIREMENT	UL & Canadian Models: 120 V, 60 Hz General Model: 230 V, 50/60 Hz British Model: 240 V, 50 Hz
POWER CONSUMPTION	H7000: 600 W/900 VA H5000: 500 W/700 VA H3000: 400 W/500 VA
DIMENSIONS W × H × D	480 × 100.5 × 455.8 (mm) Panel height: 88 mm Depth behind front panel: 407 mm
WEIGHT	H7000: 26.5 kg H5000: 23.5 kg H3000: 17.5 kg
CONNECTORS	INPUT XLR-3-31 type × 2 XLR-3-32 type × 2 1/4" Phone (balance) × 2 OUTPUT 5-way binding posts × 2 MONITOR & REMOTE D-SUB 15pin female
MONITOR & REMOTE	MONITOR Pre Relay Output Level × 2 CLIP/LIMIT Indicator × 2 Output ON Indicator × 2 TEMP Indicator REMOTE CONTROL Muting (Output Relay) × 2 Power OFF

0 dB = 0.775 V, Half Power = 1/2 Power Output Level (Rated Power)

• Dynamic Power	(H7000)	(H5000)	(H3000)
f = 1 kHz, 20 ms			
RL = 2 Ω, STEREO	2000 W	1500 W	1000 W

Specifications subject to change without notice.

For European Model

Purchaser/User information specified in EN55103-1 and EN55103-2.

Inrush Current: 2A

Conformed Environment: E1, E2, E3 and E4.

MONITOR/REMOTE Connection Pin Outs

Pin No.	Function	Parameter	Signal	Condition	
1	MONITOR	Output Level (Pre Relay)	A ch	+4 dB at 100 W/8 Ω	RL=7.5 kΩ, Zo=300Ω
2			B ch		
3		Clip/Limit ON/OFF	A ch	ON: +5 V/Zo=270 Ω OFF: 0 V/Hi-Zo	THD ≥ 0.5%
4			B ch		
5		Output ON/OFF	A ch		Output Relay ON
6			B ch		
7		Heatsink Temp.			Temp ≥ 85°C
8	REMOTE CONTROL	Mute ON/OFF	A ch	Connect to GND (Pin 15) to mute	
9			B ch		
10		Power ON/OFF		Connect to GND (Pin 15) to power off	
11	N/C				
12					
13					
14					
15	GND				

Troubleshooting

The following table lists the main causes of abnormal operation and the corrective measures required, as well as the protective circuit operation in each case.

Indicator	Probable Cause	Remedy	Protection Circuit
CLIP/LIMIT indicator lights up	Input signal level is excessive.	Adjust the input attenuators.	Power limiter protect the output transistors.
	Short at the speaker terminals, amplifier terminals, or cables.	Locate and correct the short.	
	Speaker load impedance is too low.	Use 4 Ω speakers for Stereo and Dual Mono modes, and 8 Ω for BTL Mono mode.	
TEMP indicator lights up	Heat sink temperature has exceeded 80 degrees centigrade.	Check the ventilation slots, and improve the airflow around the amplifier.	Thermal protection circuit protects the output transistors.
TEMP indicator flashes	Heat sink temperature has exceeded 90 degrees centigrade.	Check the ventilation slots, and improve the airflow around the amplifier.	
INPUT SIGNAL indicator flashes, but the OUTPUT SIGNAL indicator does not, and no sound is output.	One of the protection circuits is active.	Check the status of the front panel indicators.	

Cleaning the Filter Elements

To ensure adequate cooling air intake, the filter element must be cleaned when it has become clogged. The following points describe the cleaning procedure:

1. Make sure the power to the amplifier is OFF.
2. Remove the power plug from the AC mains socket.
3. Remove the two screws that secure the front filter grilles to the amplifier.
4. Remove the filter elements, and wash in plain water. If the filter elements are exceptionally dirty, detergent (washing-up liquid) may be used.
5. Dry the filter elements thoroughly.
NEVER REPLACE THE FILTER ELEMENTS WHILE THEY ARE STILL WET!
Replace the elements and front filter grilles. (The replacement part number of the filter element is VL86960.)

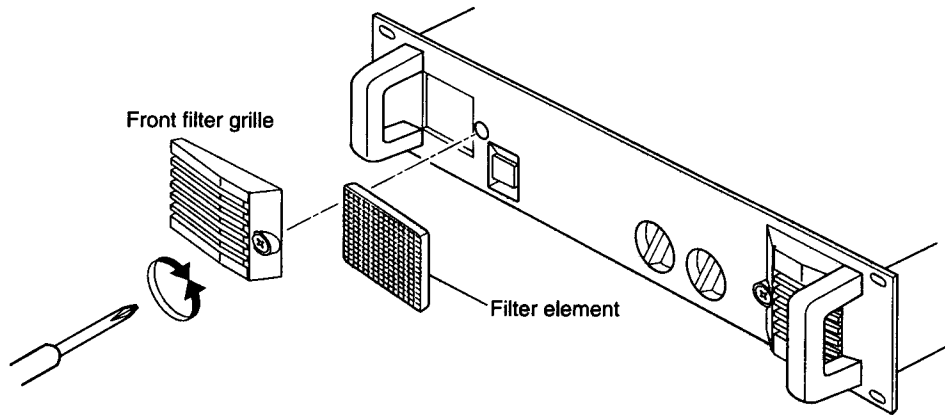

Dimensions

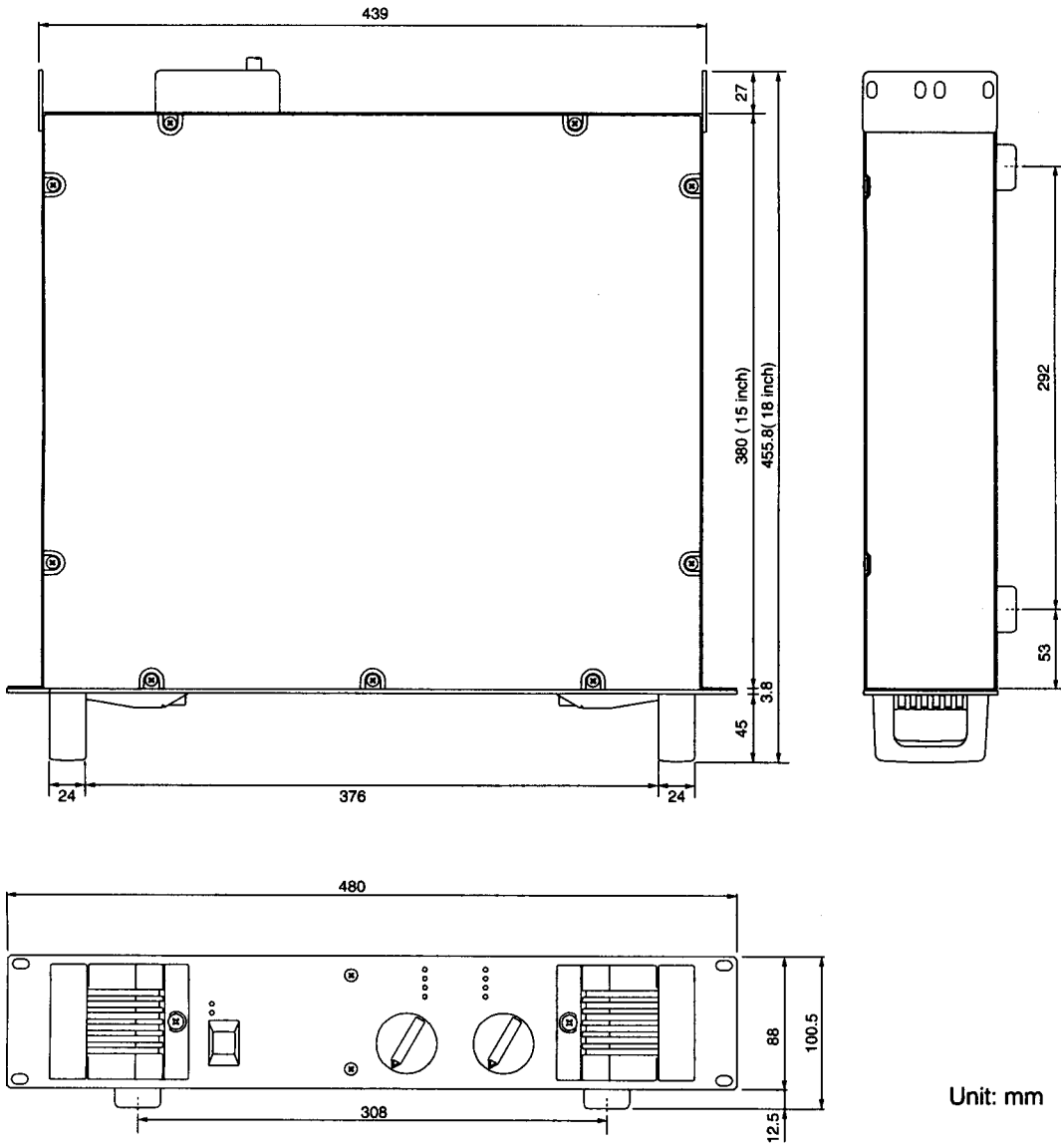

Unit: mm

Performance Graphs

— H7000, H5000, H3000 —

FREQUENCY RESPONSE

LOAD : 8 Ω
Output Power = 1 W

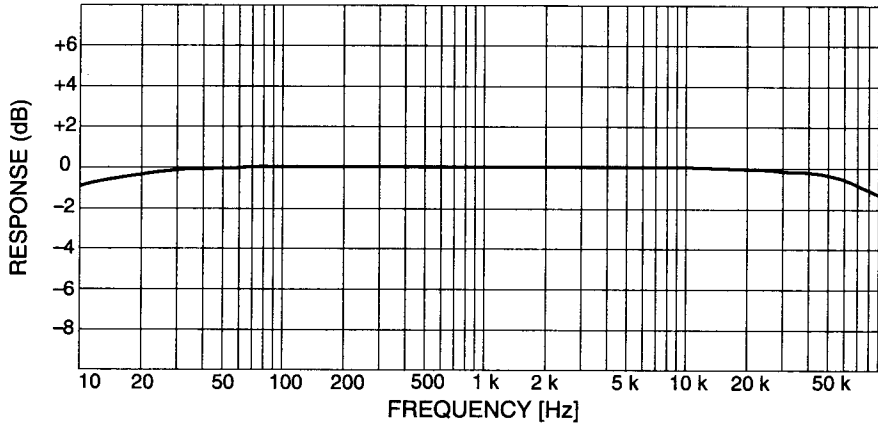

DAMPING FACTOR vs FREQUENCY

LOAD : 8 Ω

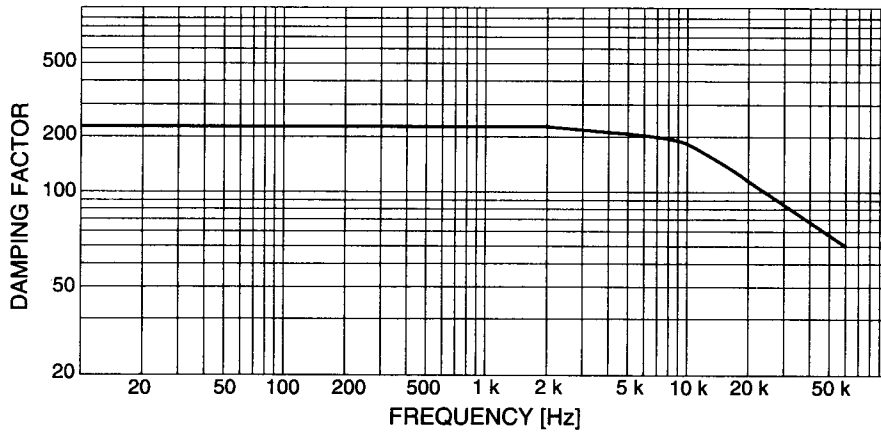

CHANNEL SEPARATION

LOAD : 8 Ω
Half Power
Measuring Ch. Input 600 Ω Shunt.

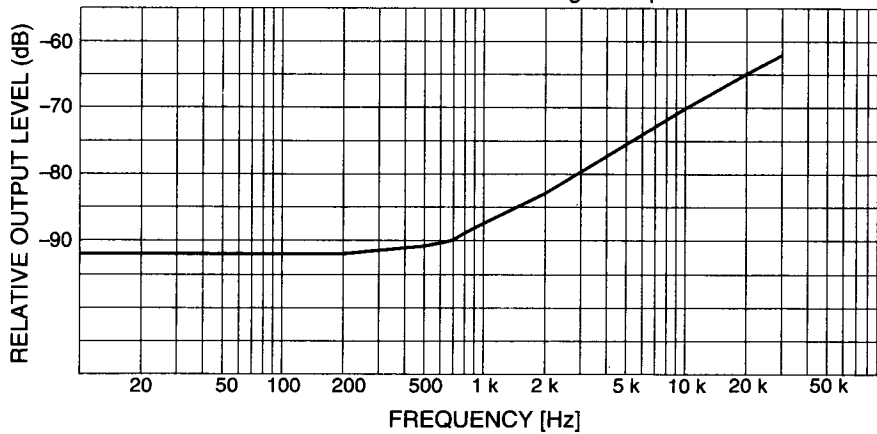

H7000

THD + N vs OUTPUT POWER

MODE : STEREO
Both Ch. Driven
LOAD : 8 Ω

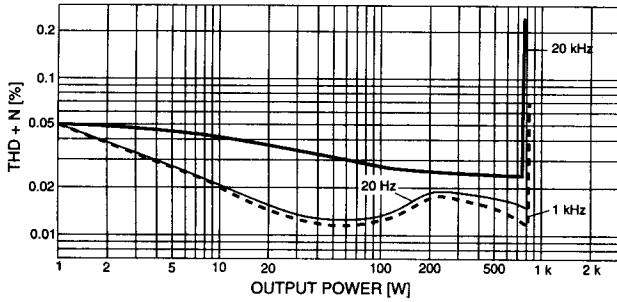

THD + N vs FREQUENCY

MODE : STEREO
Both Ch. Driven
LOAD : 8 Ω
Output Power = 375 W constant

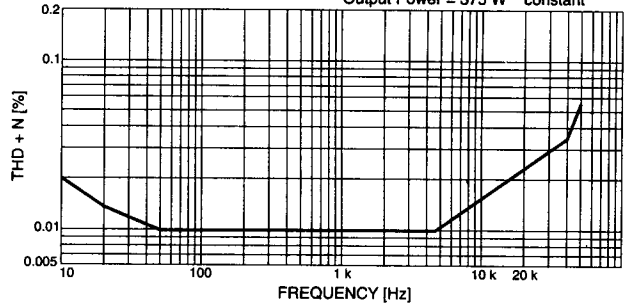

THD + N vs OUTPUT POWER

MODE : STEREO
Both Ch. Driven
LOAD : 4 Ω

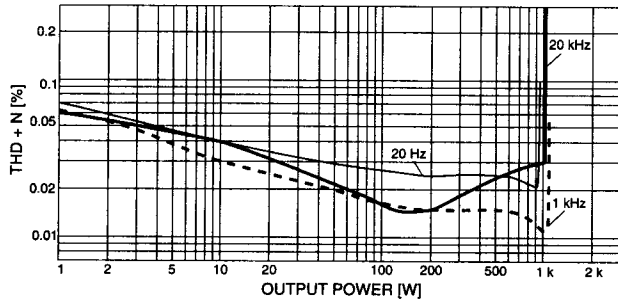

THD + N vs FREQUENCY

MODE : STEREO
Both Ch. Driven
LOAD : 4 Ω
Output Power = 475 W constant

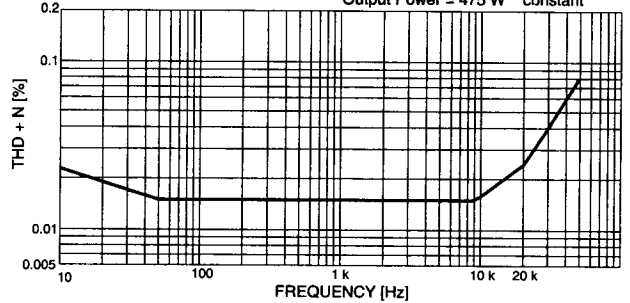

THD + N vs OUTPUT POWER

MODE : BRIDGE
LOAD : 8 Ω

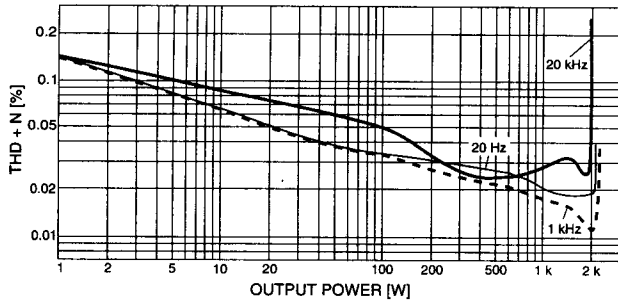

THD + N vs FREQUENCY

MODE : BRIDGE
LOAD : 8 Ω
Output Power = 950 W constant

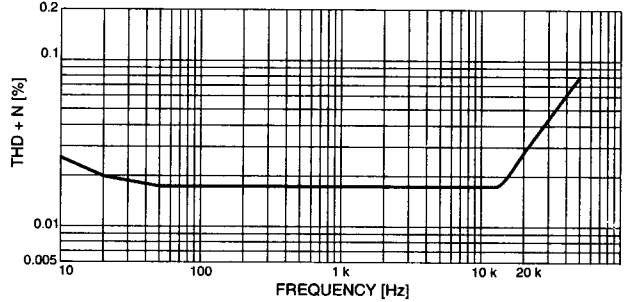

POWER CONSUMPTION vs OUTPUT POWER

MODE : STEREO
Both Ch. Driven
f = 1 kHz

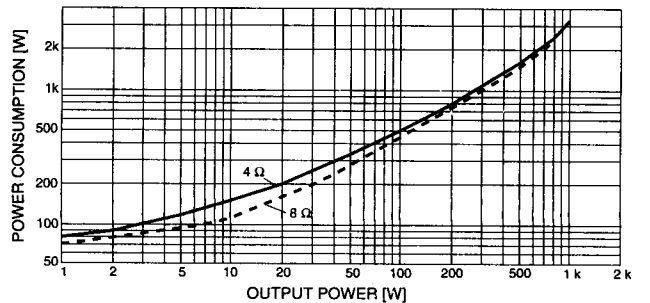

H5000

THD + N vs OUTPUT POWER

MODE : STEREO
Both ch. Driven
LOAD : 8 Ω

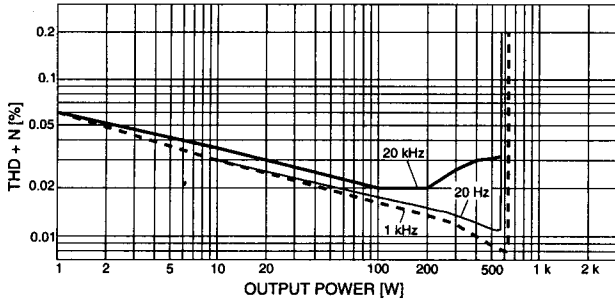

THD + N vs FREQUENCY

MODE : STEREO
Both Ch. Driven
LOAD : 8 Ω
Output Power = 275 W constant

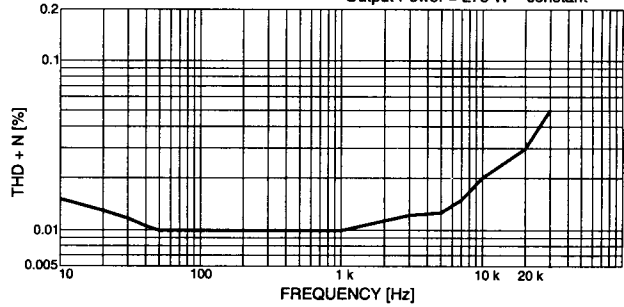

THD + N vs OUTPUT POWER

MODE : STEREO
Both ch. Driven
LOAD : 4 Ω

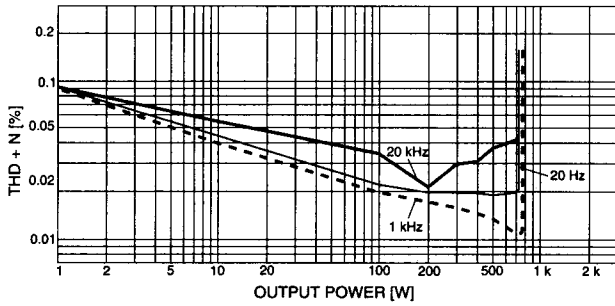

THD + N vs FREQUENCY

MODE : STEREO
Both Ch. Driven
LOAD : 4 Ω
Output Power = 375 W constant

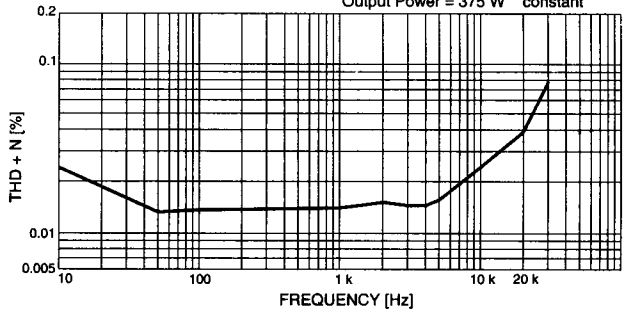

THD + N vs OUTPUT POWER

MODE : BRIDGE
LOAD : 8 Ω

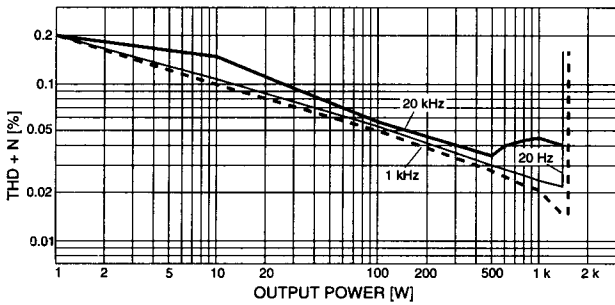

THD + N vs FREQUENCY

MODE : BRIDGE
LOAD : 8 Ω
Output Power = 750 W constant

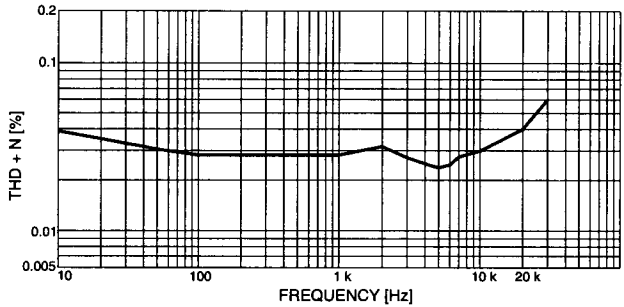

POWER CONSUMPTION vs OUTPUT POWER

MODE : STEREO
Both Ch. Driven
f = 1 kHz

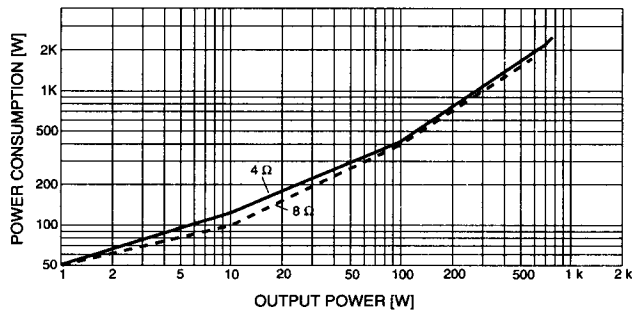

H3000

THD + N vs OUTPUT POWER

MODE : STEREO
Both Ch. Driven
LOAD : 8 Ω

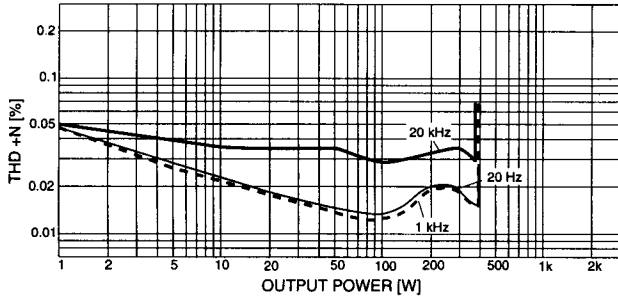

THD + N vs FREQUENCY

MODE : STEREO
Both Ch. Driven
LOAD : 8 Ω
Output Power = 175 W constant

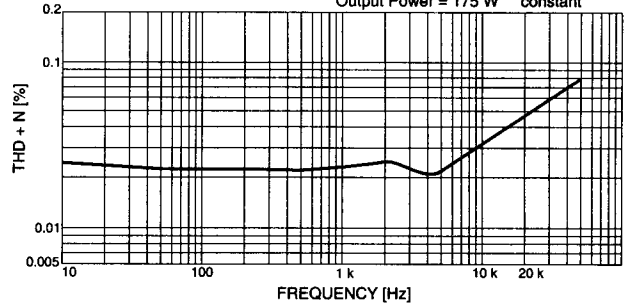

THD + N vs OUTPUT POWER

MODE : STEREO
Both Ch. Driven
LOAD : 4 Ω

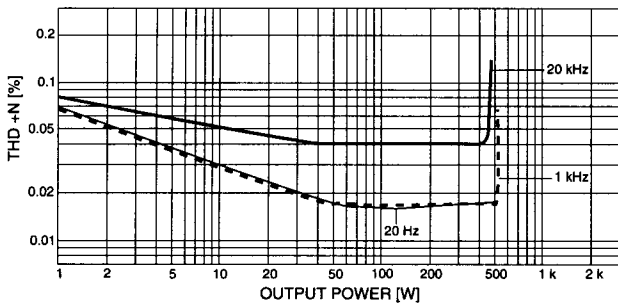

THD + N vs FREQUENCY

MODE : STEREO
Both Ch. Driven
LOAD : 4 Ω
Output Power = 225 W constant

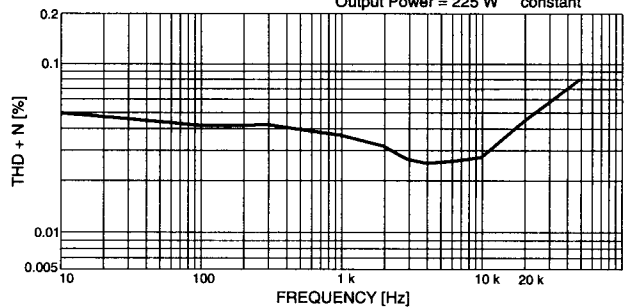

THD + N vs OUTPUT POWER

MODE : BRIDGE
LOAD : 8 Ω

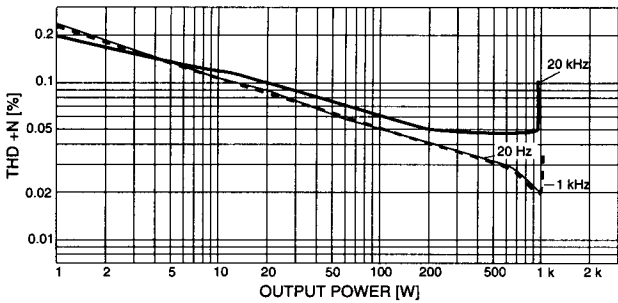

THD + N vs FREQUENCY

MODE : BRIDGE
LOAD : 8 Ω
Output Power = 450 W constant

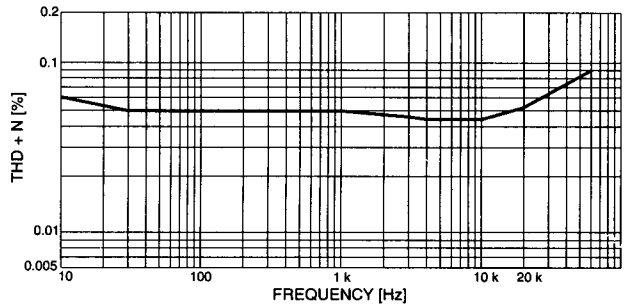

POWER CONSUMPTION vs OUTPUT POWER

MODE : STEREO
Both Ch. Driven
f = 1 kHz

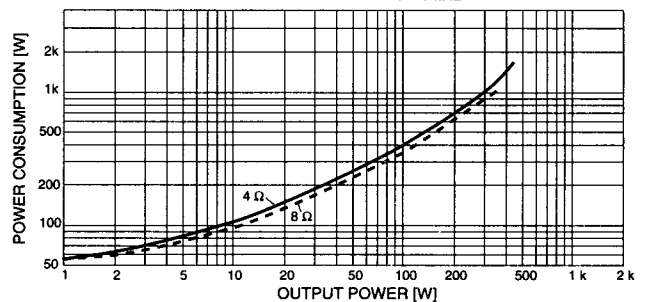

Block Diagram

